

FIG. 1

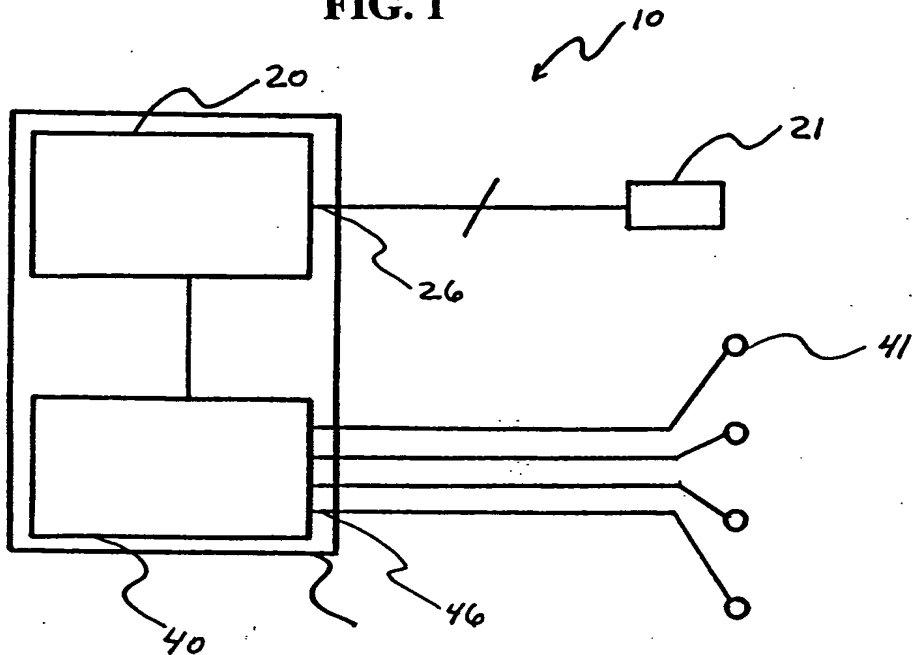
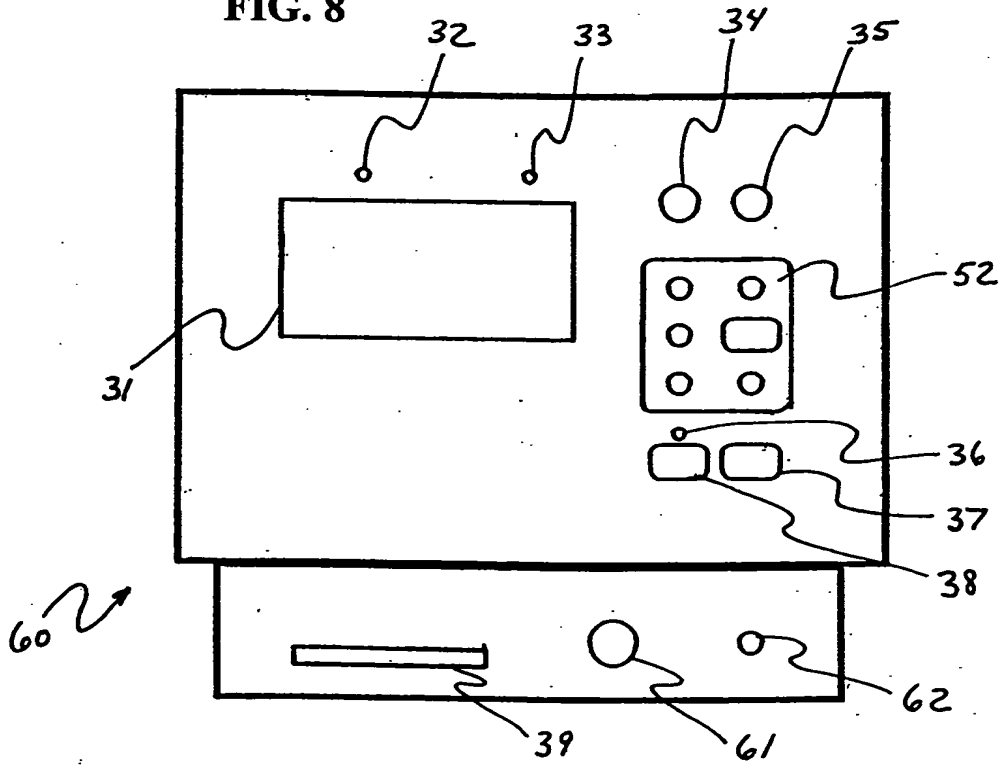

FIG. 8



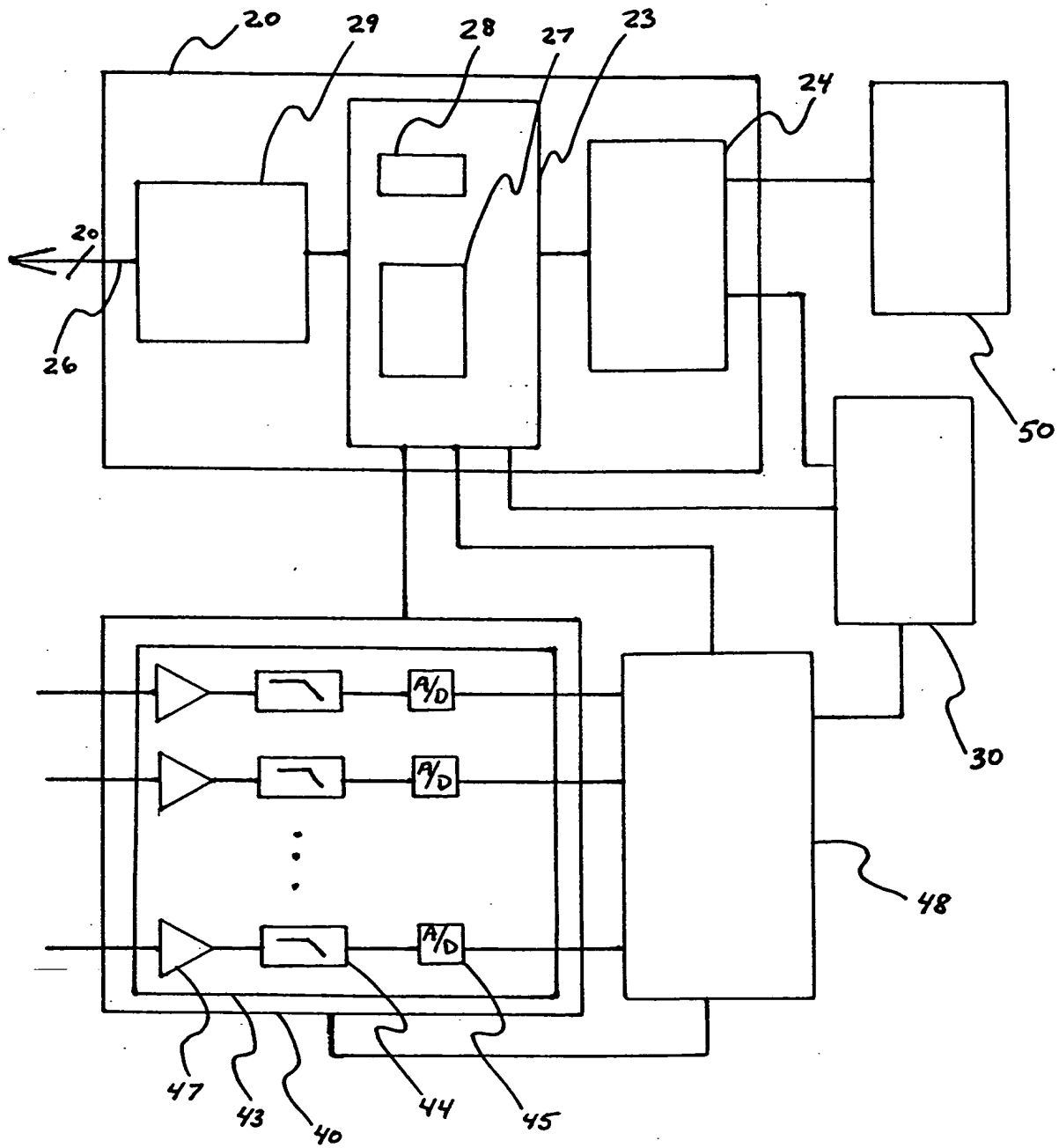

FIG. 2

FIG. 3

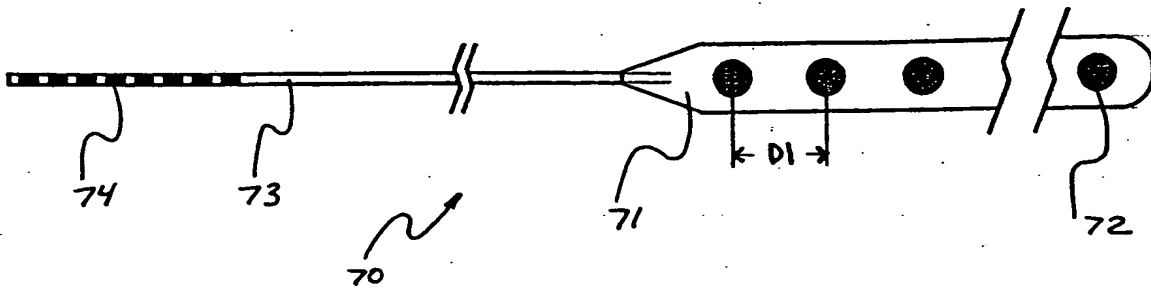

FIG. 4

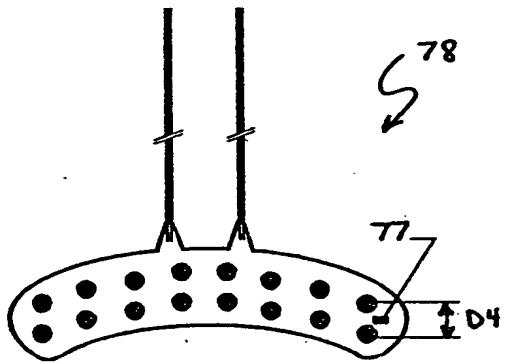
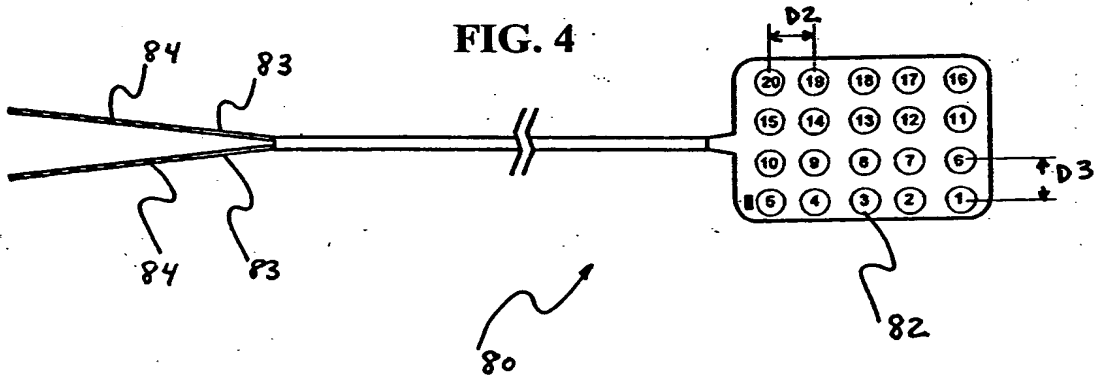

FIG. 5

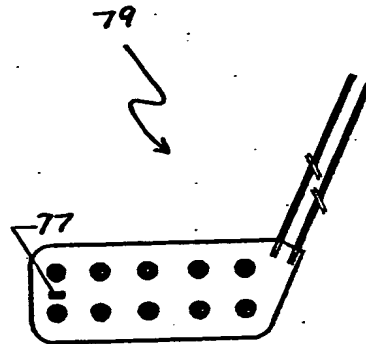
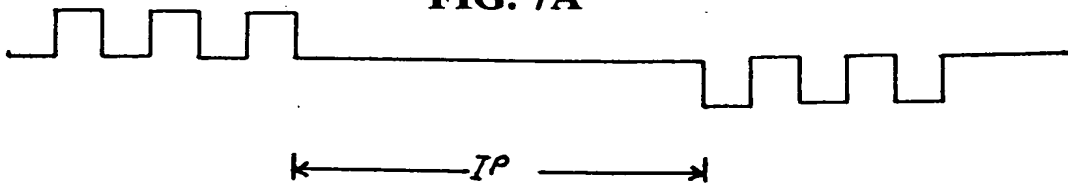
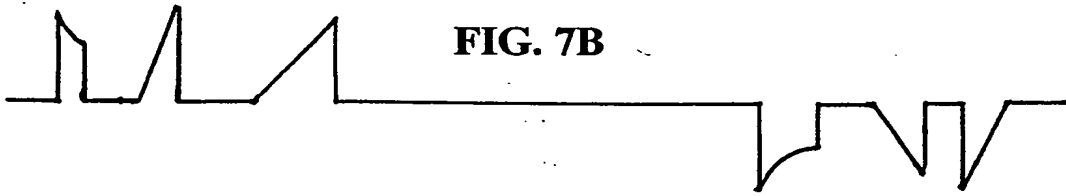

FIG. 6

**FIG. 7A**



**FIG. 7B**



**FIG. 7C**



**FIG. 7D**

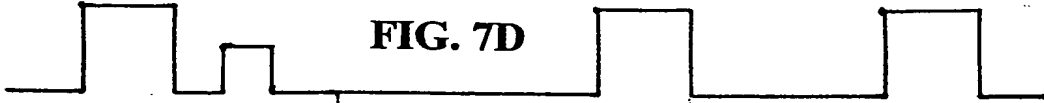

52

FIG. 9A

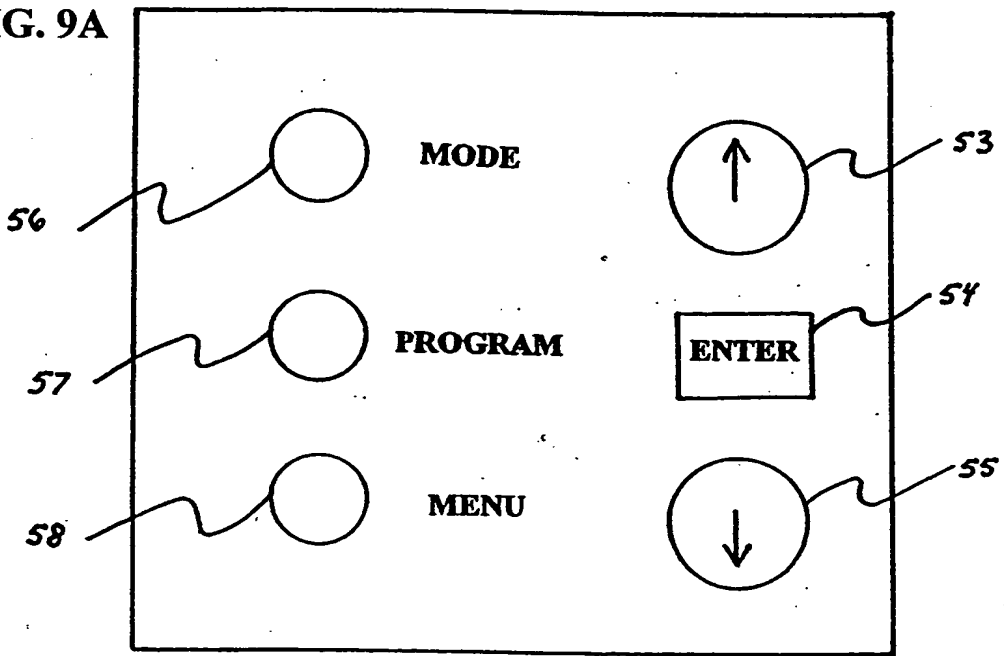
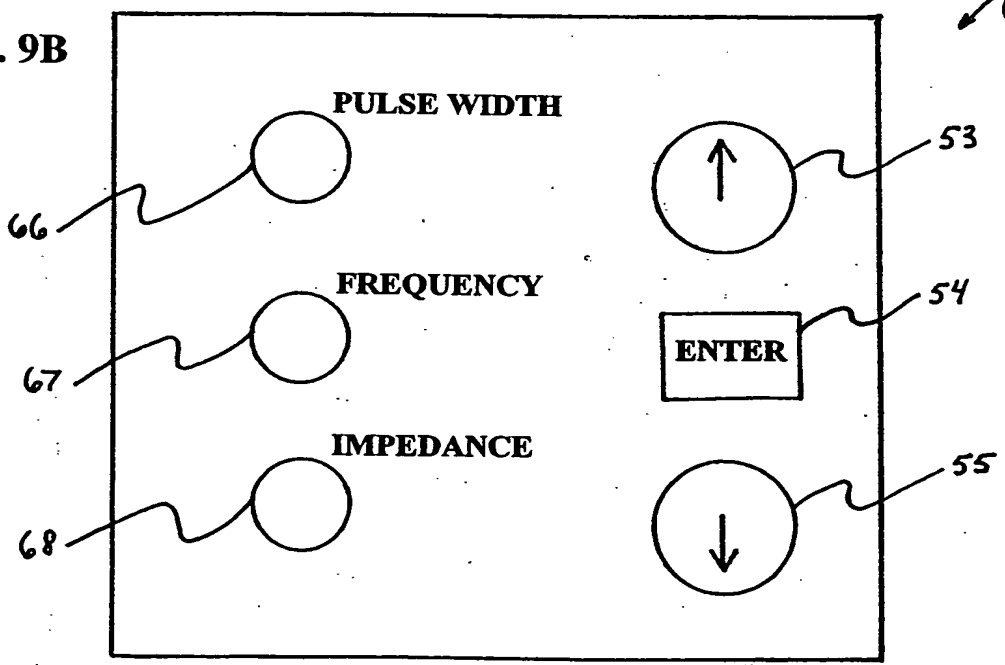

FIG. 9B



**FIG. 10A**

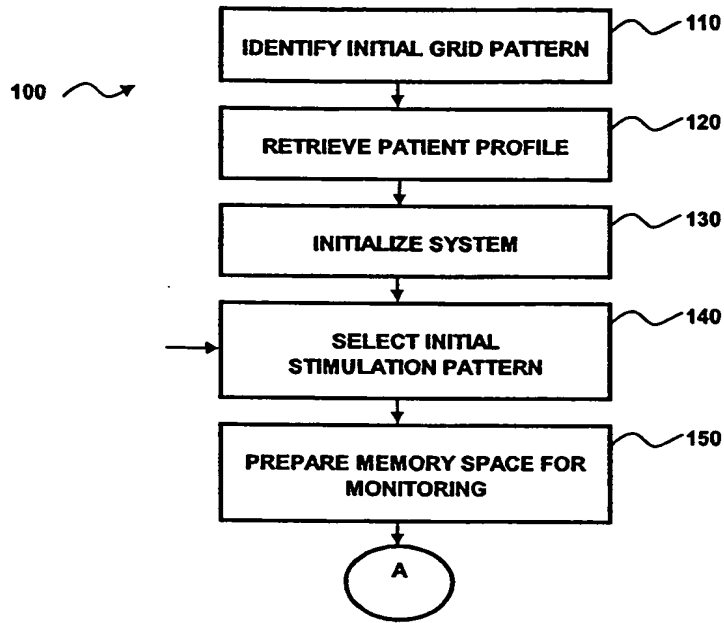

FIG. 10B

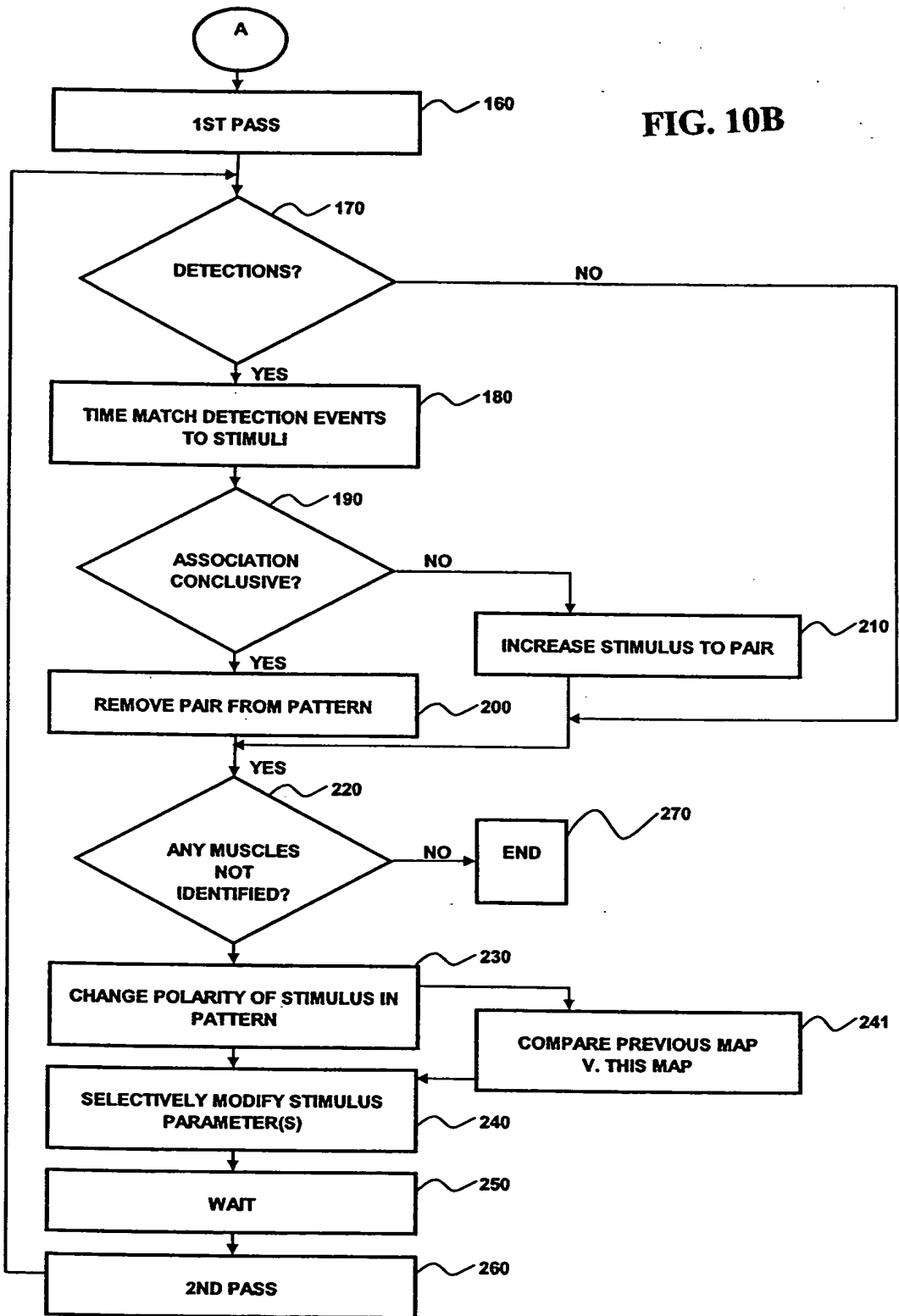
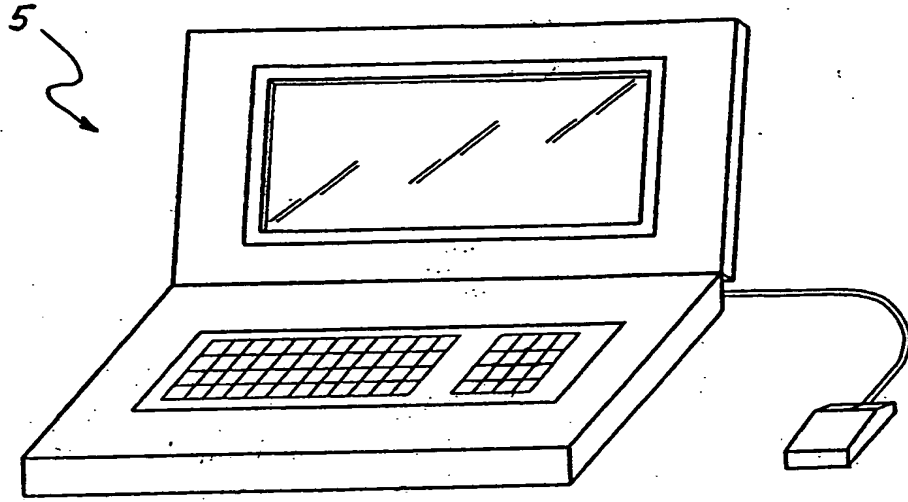

FIG. 11





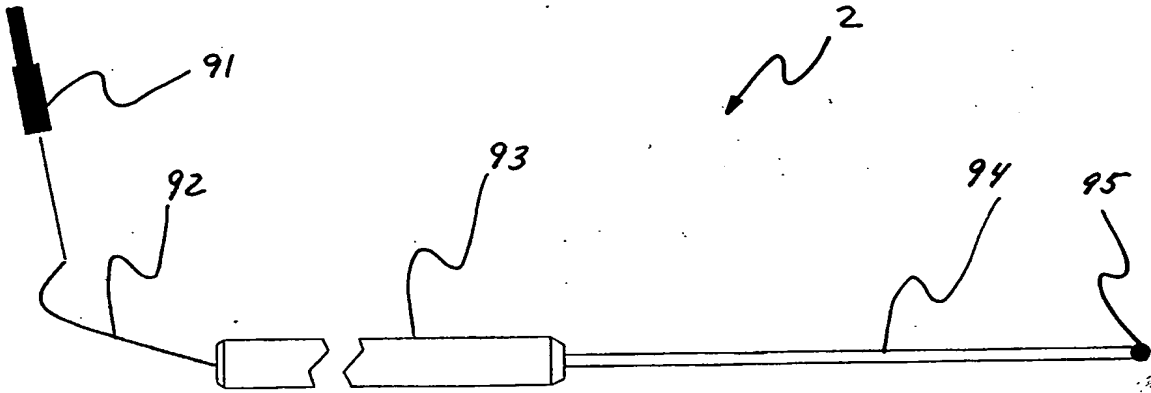

FIG. 12A

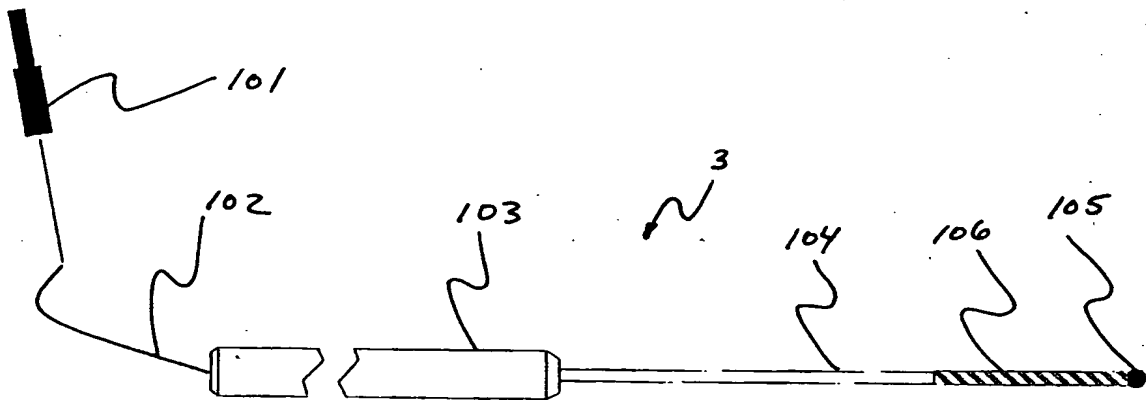

FIG. 12B

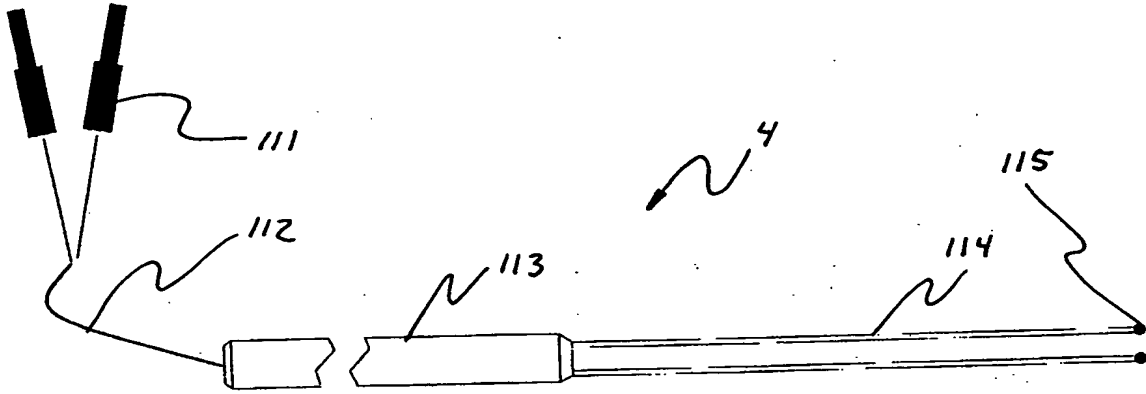

FIG. 13A

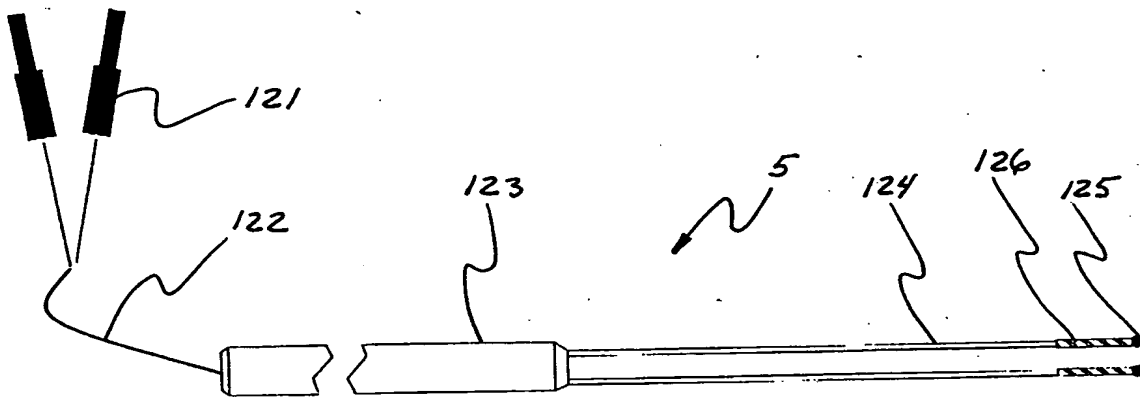

FIG. 13B

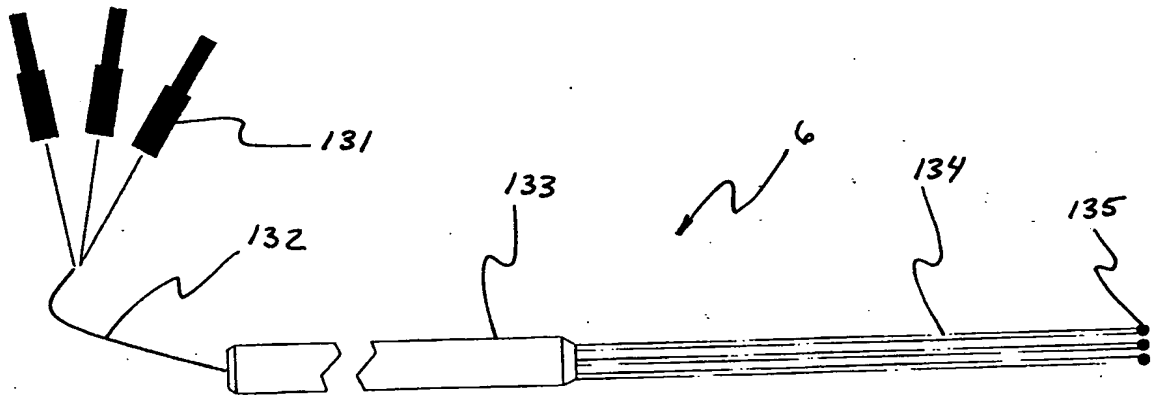

FIG. 14A

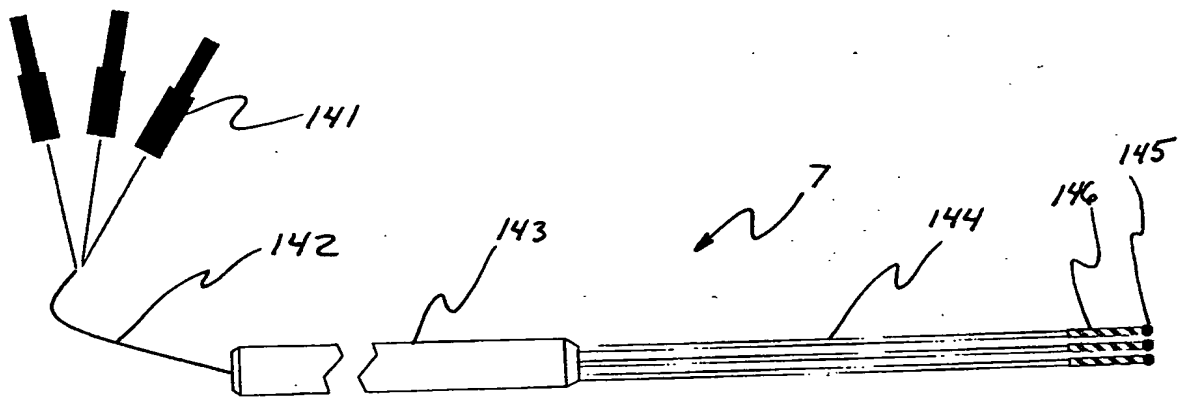
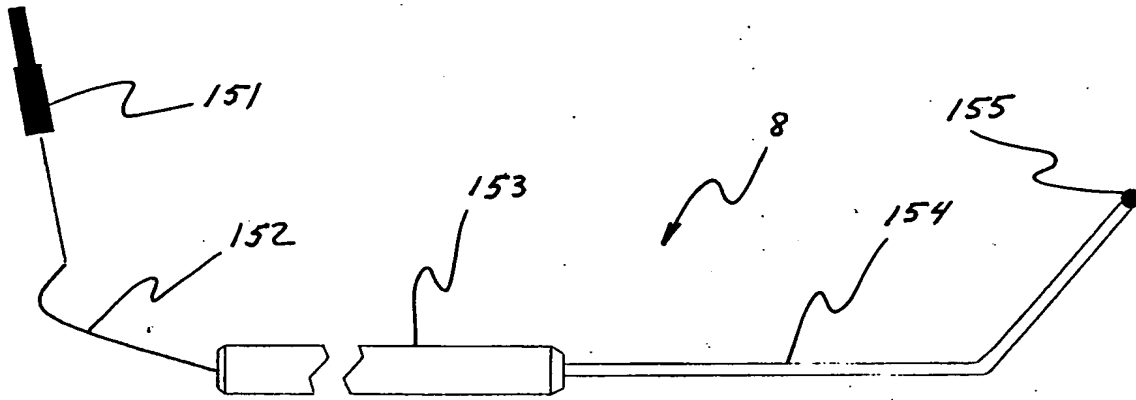
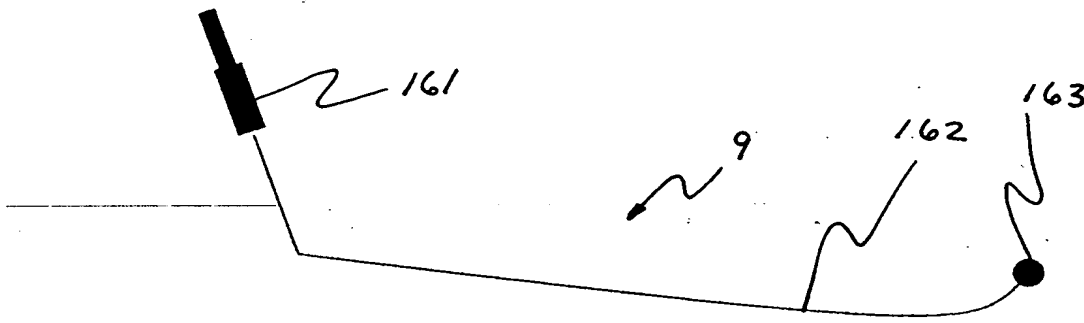

FIG. 14B



**FIG. 15**



**FIG. 16**